

## **SONOPULS** Ultrasonic Homogenizers

From generator operating software version 2.0



Ultrasonic Homogenizer HD 3100

Valid for:

HD 3100	Volumes:	1 ml - 500 ml
HD 3200	Volumes:	2 ml - 1000 ml
HD 3400	Volumes:	100 ml - 2500 ml

Copyright & limitation of liability

This document may not be reproduced, either in full or in extracts, without prior approval of BANDELIN electronic GmbH & Co. KG, hereinafter referred to as BANDELIN.

The German original is the binding version of this document. Any differences in the translation are not binding and have no legal effect. In case of any discrepancies between the translation and the original of this document, the original version has priority.

BANDELIN accepts no responsibility or liability for damages caused by improper handling or usage contrary to the intended purpose.

The documentation was prepared with great care. Liability for indirect or direct damages arising because of incomplete or erroneous information in this documentation, as well as in its delivery and usage, is excluded.

© 2016

**BANDELIN** *electronic* GmbH & Co. KG, Heinrichstrasse 3 – 4, Germany, 12207 Berlin,

Tel.: +49-30-768 80 - 0, Fax: +49-30-773 46 99, [info@bandelin.com](mailto:info@bandelin.com)

# General

The equipment, the accessories and the preparations are to be used in accordance with the Instructions for Use and/or the product information.

The instructions are part of the scope of delivery and are to be stored in the vicinity of the device for later reference. This also applies if possession of the device is transferred elsewhere.











Before the device is put into operation, these Instructions for Use are to be read carefully and completely in order for the user to become familiarised with all functions.

The warnings and safety precautions (section 1.5) are always to be followed during use.

The manufacturer will not assume any responsibility for the device's safety or functional ability in the event of improper handling or usage contrary to the intended purpose. In the event of unauthorised alterations/modifications, both the warranty claim and the CE conformity will be void.

If Service is required, please contact the specialist dealer in charge or the manufacturer.

## Symbols used:

Symbol	Significance	Explanation
	Danger	Identifies information that could signify a risk to life and limb, especially through electric shock, if not observed.
	Caution	Identifies information that is to be observed and adhered to without fail, to prevent damage to the device and danger to the user.
	Warning	Warning of hot surface.
	Important	Identifies information that is important for execution.
	Note	Identifies information provided for explanatory purposes.
	In vitro diagnostics information	Identifies information that is important for in vitro diagnostics applications.
	Medical note	Identifies information that is important for medical use.
	Do not grip inside	For health reasons, touching the oscillating fluid is prohibited.
	Wear hearing protection	For health reasons, standing for long periods of time in the vicinity of the device without hearing protection is prohibited.
	Operating sequence instructions	Identifies instructions that are to be followed in the described sequence.

# Table of Contents

1	Product description .....	6
1.1	Mode of operation .....	7
1.2	Purpose .....	7
1.3	CE conformity .....	7
1.4	Technical data .....	8
1.4.1	HF Generator (GM) .....	8
1.4.2	Technical data, ultrasonic transducers .....	10
1.4.3	Remote control .....	10
1.5	Warnings and safety precautions .....	12
2	Preparation .....	14
2.1	Scope of delivery .....	14
2.2	Set-up / assembly .....	14
2.3	Start-up .....	15
3	Operation .....	15
3.1	Operating elements .....	15
3.1.1	Turning the homogenizer on/off .....	16
3.1.2	Explanation of the display fields .....	16
3.2	Setting the operating parameters .....	16
3.2.1	Sonication time [time] .....	17
3.2.2	Pulsation [pulse] .....	18
3.2.3	Temperature monitoring [temp] .....	19
3.2.4	Special functions .....	20
3.3	Loading / saving sonication programmes .....	22
3.4	Activating / deactivating the ultrasound .....	23
4	Use .....	24
4.1	Instructions for use .....	24
4.2	General use .....	24
4.3	Selection of suitable probe .....	26
4.3.1	Mounting and dismounting of the probes .....	27
4.3.1.1	Mounting and dismounting of the titanium plates .....	28
4.3.1.2	Mounting and dismounting of micro- and tapered tips and long probes .....	29
4.4	Mounting and dismounting of the standard and booster horns .....	30
5	Cleaning and maintenance of the homogenizer .....	32

5.1	Cleaning and care .....	32
5.2	Treatment of contaminated parts in the ultrasonic transducer, vessels and accessories pertaining to the medical field .....	33
5.3	Warehousing / storing .....	33
6	Maintenance and repair .....	34
6.1	Maintenance .....	34
6.2	Functional checks .....	34
6.2.1	Testing the ultrasonic transducer (probe check) – Error 011 .....	34
6.2.2	Conducting a frequency scan (scan frequency) – Error 002/011/012 .....	34
6.3	Error analysis .....	36
6.4	Repairs and service .....	39
6.4.1	Decontamination certificate .....	39
6.4.2	Software version display .....	39
7	Accessories .....	40
7.1	Required accessories .....	40
7.2	Optional accessories .....	40
7.3	Preparations - not applicable - .....	41
8	Consumable materials - not applicable - .....	41
9	Taking the unit out of service .....	41
10	Key words .....	41

## **Informative appendices**

A	Options and accessories
B	Spanner for mounting/dismounting
C	Electromagnetic ambient conditions (EMC)
D	Decontamination - Master copy

# 1 Product description

The SONOPULS ultrasonic homogenizer is essentially made up of three components: the HF generator, the ultrasonic transducer, and the working tip (probe). The individual components can be varied using a multitude of options and accessories. The type specification and serial number are found on the type plate.

## Product features:

- HF generator (1) in low-maintenance, robust plastic housing, with connections for the ultrasonic transducer and the temperature sensor (2). (on the rear side in the case of the HD 3400)
- Operating and display panel (3) with LCD display (4)
- Ultrasonic transducer (5) with Start/Stop button (5a)
- Ultrasonic oscillating system (6)
- Booster horn (7)
- Probe (8)



## Product features on the rear side of the HF generator:

- Mains switch (9)
- Mains socket (10) with fuse holder
- Heat sink (11) - only available for HD 3200 and HD 3400
- HF socket (12)
- Remote control sleeve (13)

Not shown:

- Opening for IR interface on the HF generator bottom
- Recessed handle with stowing compartment - only for HD 3100 and HD 3200.

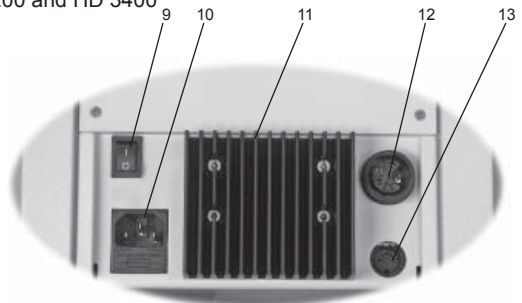

## 1.1 Mode of operation

The HF generator transforms the absorbed mains energy (mains frequency 50 or 60 Hz) into high-frequency energy with a frequency of 20 kHz. Thanks to the ultrasonic transducer that is connected to the HF generator, the high-frequency energy of the HF generator is converted into ultrasound and thus into mechanical energy. This takes place with an efficient and robust PZT ultrasonic oscillating system. Thus, mechanical deflections with a similar frequency of 20 kHz, which are transferred into the sonication medium as ultrasound waves with a high power intensity, are generated on the tip of the probe. The amplitude is held constant by the ultrasonic transducer (AMPLICHRON® system), independently from the applied load, using a signal feedback as long as the maximum power allowed is not exceeded. Thanks to these measures, the reproducibility of the process parameters is guaranteed and validation of the process is supported.

Standard and/or booster horns with probes (micro tips, tapered tips or titanium plates) are mounted on the ultrasonic transducer. These work as mechanical transformers and enable a multiple mechanical amplification of the ultrasound amplitude at the tip.

## 1.2 Purpose

SONOPULS ultrasonic homogenizers generate high-performance ultrasound with high intensities and ultrasonic amplitudes, which are transferred into liquid media through working tools known as probes. They are used in laboratories, clinics, and in industrial research, and in the process they perform versatile tasks during sample preparation in Quality Assurance, scientific experiments, analyses, and in pilot or short-series manufacture.

### Application examples:

- Cell disruption for paternity tests
- Cell disruption (extraction of microorganisms, tissue cells)
- Homogenizing of liquids
- Emulsifying hard-to-mix liquids
- Dispersing of agglomerates
- Accelerating chemical reactions
- Degassing of fluids
- Sample preparation in environmental analytics (wastewater tests, soil samples)
- Sonochemistry



SONOPULS ultrasonic homogenizers are also used for in-vitro diagnostic lab procedures, to procure information from the handling of organic materials with ultrasound. Therefore, they are classified and treated in accordance with the Directive 98/79/EC on in-vitro diagnostic medical devices.

## 1.3 CE conformity

SONOPULS ultrasonic homogenizers are declared as IVD products and satisfy the CE marking criteria for the European Directives:

- IVD directive
- Low-voltage directive
- Electromagnetic compatibility directive

in their currently valid versions.

A declaration of conformity can be requested from the manufacturer by providing the serial number.

## 1.4 Technical data

SONOPULS ultrasonic homogenizers are interference-free and marked with a  $\text{C}\text{E}$ .  
Compliance with limit values pursuant to EN 55011, EN 61000-6-1/08.2002, EN 60601-1-2 and EN 61326-1.

### 1.4.1 HF Generator (GM)

Mains connection:	230 V~ ( $\pm 10\%$ ) 50/60 Hz, alternatively 115 V~ ( $\pm 10\%$ ) 50/60 Hz, cable length 2 m
Ultrasound frequency:	20 kHz $\pm$ 500 Hz
Frequency control <sup>1</sup> :	automatic, resonance frequency search
Time setting range:	0:00:01 – 9:59:59 [h:mm:ss] or continuous operation
Ultrasound operating mode:	pulsating or continuous
Pulsation time ON ( $t_{\text{E}}$ ):	0.1 - 600s - (see chapter 3.2.2)
Pulsation time OFF ( $t_{\text{A}}$ ):	0.2 - 600s - (see chapter 3.2.2)
Ultrasound control:	Amplitude or power - (see chapter 3.2.4)
Amplitude setting range:	10 - 100 % in 1 % steps
Amplitude display / power display:	Presetting and progress bars
Energy display:	kJ
Temperature sensor:	TM 100, optional
Temperature display:	0 – 120 °C
Programme storage locations:	9
Operating elements:	Rotary knob, membrane keys
Operating data display:	LCD graphic display, illuminated
Remote control (turning on/off):	Button on the ultrasonic transducer, potential-free contact, foot switch TS 8 (optional)
Digital interface:	Infrared (RS-232, half-duplex), infrared adapter IR 1 (optional)
Degree of protection:	IP 31 according to DIN 60529

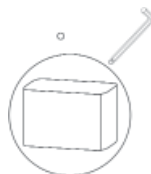

Protected against access by instruments to dangerous components, protected against solid foreign bodies with a diameter of 2.5 mm or larger



Protected from dripping water

<sup>1</sup> Frequency control:

The HF generator has the possibility to search automatically for the resonance frequency and rate adaptation while in operation. Causes for a change in the resonance frequency are, e.g., a warming of the ultrasonic transducer and the probes, a change in the acoustic load due to changes in viscosity, and also the mounting of another probe. A frequency drift during operation is corrected by the automatic frequency control. The optimum working frequency is sought using the resonance frequency search, e.g. after a change in probe.



**Device-specific:**

Generator	GM 3100	GM 3200	GM 3400
HF-power <sup>2</sup> , maximum	100 W	200 W	400 W
HF frequency	20 kHz	20 kHz	20 kHz
Power setting range	10 – 75 W	25 – 150 W	60 – 300 W
Weight	2.0 kg	2.7 kg	3.1 kg
Dimensions (L × W × H)	250 × 155 × 257 mm		324 × 230 × 131 mm

**Environmental conditions pursuant to EN 61 010-1**

Overvoltage category:	II
Degree of contamination:	2
Permissible relative humidity up to 31 °C:	80 %
Permissible relative humidity up to 40 °C:	50 %
Permissible ambient temperature:	5 to 40 °C
No dewing allowed.	
Only for indoor operation.	

**Specifications for use as a medical device****IVD**

Name:	Ultrasonic Homogenizer
UMDNS nomenclature (ECRI / DIMDI):	17-125
Purpose:	see chapter 1.2
Medical device pursuant to	
Directive 98/79/EC for in-vitro diagnostics:	Category 5 device (miscellaneous)
Type, model, serial number, year of manufacture:	See type plate on the generator for information

The homogenizer has been inspected pursuant to norms currently in effect and is to be installed and put into operation pursuant to EMC directions; information in this respect is found in the appendix.

**Specifications pursuant to the Medical Devices Operator Ordinance (MPBetreibV):**

Commissioning on site, functional check and personnel instruction (section 5):		Not required
Technical safety controls (section 6):		No specifications
Technical measurement controls (section 11):		N/A

**Specifications as per DIN EN 60601-1 / VDE 0750 Part 1 / IEC 601-1:**

Protection class:	I
Protection type (B, BF, CF):	Not applicable, as no application part present

**e-procurement**

e-cl@ss:	
HD device classification:	32-08-02-02
HD accessories classification:	32-08-92-03

<sup>2</sup> HF power:

In the case of amplitude control, the ultrasonic power that is needed for the desired probe amplitude is dependent on the viscosity of the medium. In order to prevent damages to the HF generator and converter, the power is limited to the maximum-allowed peak value. In the case of highly viscous media, this can also result in the desired amplitude not always being reached.

## 1.4.2 Technical data, ultrasonic transducers

	UW 3100 / UW 3200	UW 3400
PZT ultrasonic oscillating system:	✓	✓
Start/Stop button:	✓	-
Suitable for continuous operation:	✓	✓
Frequency:	20 kHz	20 kHz
Weight:	1.2 kg	2.2 kg
Dimensions:	Ø 70 × 120 mm	Ø 90 × 180 mm
Degree of protection:	IP 20	IP 20

Environmental conditions, see chapter 1.4.

## 1.4.3 Remote control

Several options are available for remote control and remote operation. Depending on requirements, the most convenient solution may be selected.

	Operating element	Method	Functions	Connection
1	button	manual	Ultrasound operation ON/OFF	Fixed on the ultrasonic transducer
2	foot switch	foot-operated	Ultrasound operation ON/OFF	Remote control connector
3	external	control signal	<ul style="list-style-type: none"> <li>• Ultrasound operation ON/OFF</li> <li>• Status confirmation</li> </ul>	Remote control connector
4	external	data protocol	<ul style="list-style-type: none"> <li>• Status inquiry</li> <li>• Full device control</li> </ul>	Infrared interface (RS-232 IR half-duplex)

### a) Remote control connector

Contact assignment and functional description of the remote control connector

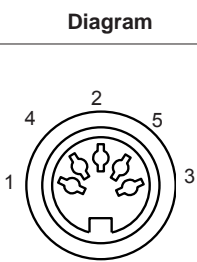
Diagram	Contact	Assignment	Signal	Function
	1	Input	0V L 5V H	L → Ultrasound operation ON H → Ultrasound operation OFF
	2	not connected		
	3	Mass		
	4	Output	0V L 5V H	L → Ultrasound operation OFF H → Ultrasound operation ON
	5	Output		as with contact 4, but signal inverted

**Notes:**

- The inputs and outputs may not be connected to other circuits, ground planes, or ground terminals.
- The connection of power or voltage sources of any type is not permitted.
- The source resistance for the outputs is of 2.2 kΩ. The input resistance for subsequent signal inputs, e.g. optocouplers, must be greater than 20 kΩ.
- The function of the signal input (contact 1) depends on the type of operation that is set for the pulsation (see chapter 3.2.2). With the operating mode “by hand key”, control is conducted statically, i.e. the ultrasound operation is always activated under L status, and deactivated under H status. With all other types of operation, the input works as an edge-controlled changeover switch.
- When connecting a changeover contact (toggle function) to connector 1, the make time must be > 100 ms.

**b) IR interface**

The IR interface on the bottom of the HF generator must always point to the right.

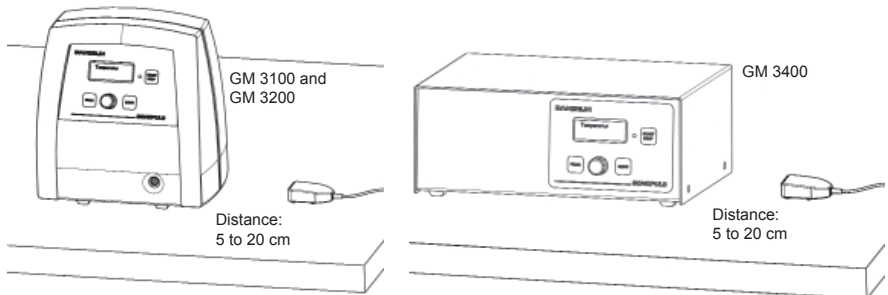
**Positioning of the IR adapter**

For communication purposes, a commercial infrared adapter (RS-232, half-duplex) can be used. Implementation of the technical program required for this communication is the responsibility of the user and is not supported by the manufacturer. The manufacturer only guarantees the proper functioning of the interfaces.

The instruction set for the infrared interface will be made available by the manufacturer free of charge, upon request.

**Note:**

Proper operation will depend on the length of the connection cable. If an extension is used, a length of 5 m may not be exceeded.

The WINPULS remote operation programme, for operating systems Windows 2000 and Windows XP, is provided optionally, see chapter 7.

Diverse additional functions such as protocol and batch functions allow for process control and quality control to be comfortably operated via PC.



The WINPULS remote operation programme is not part of the standard product range.

## 1.5 Warnings and safety precautions

### General

- Keep the device and accessories out of the reach of children and also of persons who have not been instructed in their operation by reference to these instructions.
- The use of the device or parts thereof on humans or animals is not authorised.
- Keep the HF generator and operating elements clean and dry.
- Do not expose the unit to corroding influences.
- When working with the device, please observe hygiene instructions pursuant to chapter 5.2.
- The connection of any type of power or voltage sources to signal inputs or outputs is forbidden.
- Signal lines for foot switches, temperature sensors, etc., may not exceed a maximum length of 3 m.
- All plug connections (such as for ultrasonic transducers, foot switches) may only be plugged or unplugged while the device is turned off.
- The HF generator and ultrasonic transducer may only be transported separately.
- The homogenizers HD 3100, HD 3200 and HD 3400 adhere to prescribed EMC limit values, such that it can be assumed that the electromagnetic radiation emanating from the units is harmless to humans. A binding statement for wearers of implants can only be made at the place of work and together with the implant manufacturer. In case of doubt, information regarding the allowable electromagnetic exposure level is to be obtained from the implant manufacturer.

### Operation

- Observe ambient and set-up conditions, see chapter 1.4.
- Determine the mains voltage before connecting the HF generator. Only connect the HF generator to a grounded socket.
- Fuse protection 10 A (main circuit breaker).
- The ultrasonic transducer should only be firmly mounted on the black housing using a suitable support, e.g. stainless steel stand HG 5 or HG 10.
- Before each startup, check that the probe is firmly positioned on the standard or booster horn; if necessary, tighten the probe (see chapter 4.3.1).
- Do not touch any oscillating parts (e.g. standard or booster horns, micro tips or tapered tips, titanium plates, ultrasonic transducer) during operation! Damage to health is possible.
- Do not touch the sonication vessels with the oscillating probe - probes and vessels could be damaged.
-  The sonication of liquids generates noise. Suitable accessories, such as a sound proof box, will minimise such noise considerably. If operating without a sound proof box, wear hearing protection.
-  Warning, risk of splashing!  
This is especially the case with small sample quantities and when immersing oscillating probes.
- Do not use combustible solvents in open reaction vessels since the operating safety of the homogenizer could be compromised. Safe extraction of combustible vapours must be guaranteed. When using a sound proof box, the vapours cannot escape.
- Before any mounting or dismantling (chapter 4.4) of probes or standard/booster horns as well as accessories, turn off the device and disconnect the ultrasonic transducer from the HF generator.



- Only use the prescribed tool for mounting and dismounting (see appendix B).
- Do not use any bent probes ( $\Rightarrow$  unstable operation, loss of power).
- Liquids must not penetrate the inside of the ultrasonic transducer.
- Never twist the ultrasonic transducer's black housing toward the aluminium cylinder (ultrasonic oscillating system). The ultrasonic oscillating system and its electrical connections would be destroyed as a result.
- Do not operate the device without supervision.

#### **IVD** Advice for the medical and laboratory field

- The homogenizer is exclusively intended for use by skilled medical personnel.
- It may generate radio interferences or disrupt the operation of devices nearby. It may be necessary to take remedial measures such as realigning the device or reconfiguring the homogenizer or the shield.
- During operation, portable or mobile RF communication systems in the vicinity of the homogenizer should be turned off - operation may be disrupted.

#### **Damages**

- If damage to the homogenizer is detected, do not connect the homogenizer to the mains.
- In the event of malfunction, disconnect the mains plug immediately.
- Repairs are only to be conducted by authorised skilled personnel or by the manufacturer.
- Defective parts must only be replaced with original parts or parts of the same quality!

## 2 Preparation

Carefully unpack the HF generator, ultrasonic transducer and accessories, and inspect them for completeness or possible transportation damages. If any damages or defects are found, these are to be immediately notified in writing to the transportation company and to the supplier.

### 2.1 Scope of delivery

The scope of delivery will depend on the size of the order. However, it will generally include the following parts:

- 1 HF Generator GM .... - see delivery note
- 1 Ultrasonic transducer UW ...
- 1 Standard horn or booster horn SH ... (already firmly screwed-in)
- 1 Probe
- 1 Instructions for Use

Additional accessories according to order - see delivery note

### 2.2 Set-up / assembly

- Place the HF generator atop a firm, level and dry surface. In doing so,
  - do not group it or stack it over other electric or non-electric devices.
  - Do not cover the ventilation holes on the ultrasonic transducer's housing.
  - Guard against moisture and wetness - risk of electric shock.



- During delivery, the standard or booster horn is already firmly screwed to the corresponding ultrasonic transducer.  
Other standard or booster horns are mountable. To do so, see instructions in chapter 4.4.
- Screw together the supplied probe with the standard or booster horn, see chapter 4.3.1.
- Position the ultrasonic transducer safely and correctly inside the holder.  
To do so, affix the ultrasonic transducer in the sound proof box's supporting ring (e.g. LS 8, LS 4 or LS 11) or firmly mount the ultrasonic transducer on the black housing only, using a suitable support, e.g. stainless steel stand HG 5 or HG 10.
- Connect the ultrasonic transducer to the HF generator.  
To do so, insert the plug from the ultrasonic transducer into the HF connector located on the rear side of the generator, and tighten using the threaded ring. If necessary, see chapter 1.
- Verify that the power switch is in the "0" position.
- Before the mains connection, identify the pertinent mains voltage, compare it with the type plate on the generator bottom, and only connect a suitable type to a grounded socket.

230 V~ 50/60 Hz alternatively 115 V~ 50/60 Hz

#### Note:



- Avoid any contact between the contact pins on the ultrasonic transducer's plug, since the piezo elements could generate an electric charge through temperature fluctuations ⇒ with a possibility of slight electric shocks.

## 2.3 Start-up

- Check the positioning of the ultrasonic transducer in the holder.
- Check the firm positioning of the probe and, if needed, clean thoroughly before first use.
- Connect the HF generator to the mains (grounded socket) and switch on.
- Set the probe type (see chapter 3.1.1)
- Conduct a function test pursuant to chapter 6.2.1.

## 3 Operation

### 3.1 Operating elements

Operation is conducted from the operating and display panel on the front side of the HF generator:



1	LCD display	Display of the operating parameters and status information
2	"START/STOP" button	Starting or stopping the ultrasound emission, ending functions, leaving the menu
3	"PROG" button	Calling-up the save options, moving within the menu (backward)
4	Rotary knob	Setting the operating parameters (right/left, without dead stop)
5	"MENU" button	Calling-up the list of editable operating parameters, moving within the menu (forward)
6	Control LED	green light: Ultrasound operation blinking green: Remote control over the digital IR interface or red light: Error messages blinking red: Warning messages

### 3.1.1 Turning the homogenizer on/off

The homogenizer is turned on using the power switch on the rear side of the HF generator. After turning on, the LCD display must light up. Initialisation occurs automatically. The ultrasonic homogenizer will display the manufacturer's name, type designation, and the last-connected sonotrode [probe].

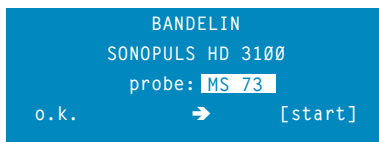

If the probe type displayed does not conform with the probe that is mounted, the correct probe type will have to be set before the next step using the rotary knob. By pressing the "START/STOP" button, the menu switches into stand-by mode and the ultrasonic homogenizer is ready for operation. The parameters used during the last operation will be set again and displayed.

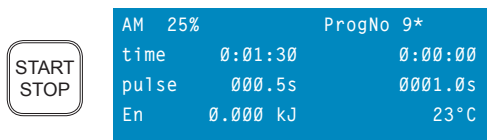

The mains switch can also be used for powering off. When the HF generator is powered off, the memory contents are saved and become available again when the generator is powered on.

### 3.1.2 Explanation of the display fields

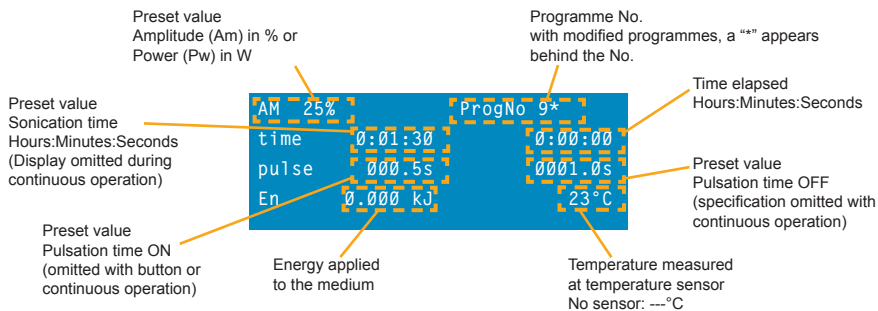

### 3.2 Setting the operating parameters

With the exception of the amplitude and power, the operating parameters can only be set while in stand-by mode (idle mode). The editing mode is activated by pressing the "MENU" button. It is possible to switch between the individual parameters by repeatedly pressing the "MENU" button. In the marked area (inverse view) of the selected parameter, the desired value is set by turning the rotary knob. By pressing the "START/STOP" button, the editing mode is exited.



The following operating parameters can be set:

- Default values for the amplitude or power [Am or Pw]
- Default values for the sonication time [time]
- Default values for the pulsation of the ultrasound (turn-on and turn-off time) [pulse]
- Limit value for the temperature monitoring [...°C]
- Operating mode for the ultrasound control [En]

The operating parameters “Energy” and “Elapsed sonication time” cannot be edited.

### 3.2.1 Sonication time [time]

A value of 9 hours, 59 minutes and 59 seconds (9:59:59) can be set as the maximum sonication time. If the set value is exceeded during ultrasound operation, the sonication will stop. The specification “non-stop” is equivalent to unlimited continuous operation until operation is ended by pressing the “START/STOP” button.

#### a) Set continuous operation [non-stop]

AM	25%	ProgNo	9*
time	0:01:30	0:00:00	
pulse	000.5s	0001.0s	
temp	off	max 35°C	



AM	25%	ProgNo	9*
time	non-stop		
pulse	000.5s	0001.0s	
temp	off	max 35°C	

#### b) Set the sonication time

If a value of 59 minutes or seconds is exceeded when setting the time, or a shortfall occurs when setting back the time, the values for the set hours or minutes will change accordingly.

AM	25%	ProgNo	9*
time	0:01:30	0:00:00	
pulse	000.5s	0001.0s	
temp	off	max 35°C	



AM	25%	ProgNo	9*
time	0:01:30	0:00:00	
pulse	000.5s	0001.0s	
temp	off	max 35°C	



0 to 9 hours

AM	25%	ProgNo	9*
time	0:01:30	0:00:00	
pulse	000.5s	0001.0s	
temp	off	max 35°C	



AM	25%	ProgNo	9*
time	0:01:30	0:00:00	
pulse	000.5s	0001.0s	
temp	off	max 35°C	

1 to 59 seconds

1 to 59 minutes



proceed to next set value or operating parameter



back to stand-by mode

### 3.2.2 Pulsation [pulse]<sup>3</sup>

In addition to the pulse turn-on time  $t_E$  and the pulse turn-off time  $t_A$ , 2 additional operating modes can also be set:

off no pulsation or continuous sound  
 by hand key it is possible to pulse manually with the button on the ultrasonic transducer. Ultrasound operation will be active as long as the button on the ultrasonic transducer is pressed.

#### a) Setting the operating modes

AM	25%	ProgNo	9*
time	0:01:30		0:00:00
pulse	000.5s		001.0s
temp	off max 35°C		



AM	25%	ProgNo	9*
time	0:01:30		0:00:00
pulse	off		
temp	off max 35°C		



AM	25%	ProgNo	9*
time	0:01:30		0:00:00
pulse	by hand key		
temp	off max 35°C		

#### b) Setting the time intervals

The maximum setting value is 600.0 s. The minimum setting value will depend on the type of device and ranges between 0.1 und 0.3 s.

AM	25%	ProgNo	9*
time	0:01:30		0:00:00
pulse	000.5s		001.0s
temp	off max 35°C		



Turn-on time  $t_E$

AM	25%	ProgNo	9*
time	0:01:30		0:00:00
pulse	000.5s		001.0s
temp	off max 35°C		



000.0 to 500.0 seconds

AM	25%	ProgNo	9*
time	0:01:30		0:00:00
pulse	000.5s		001.0s
temp	off max 35°C		



000.0 to 590.0 seconds

AM	25%	ProgNo	9*
time	0:01:30		0:00:00
pulse	000.5s		001.0s
temp	off max 35°C		



000.0 to 599.0 seconds

AM	25%	ProgNo	9*
time	0:01:30		0:00:00
pulse	000.5s		001.0s
temp	off max 35°C		



000.0 to 600.0 seconds

<sup>3</sup> The pulse period is the sum of the turn-on and turn-off times  $t = t_E + t_A$

### Turn-off time $t_A$

```
AM 25%          ProgNo 9*
time  0:01:30    0:00:00
pulse 000.5s     001.0s
temp  off max 35°C
```

000.0 to 500.0 seconds



```
AM 25%          ProgNo 9*
time  0:01:30    0:00:00
pulse 000.5s     001.0s
temp  off max 35°C
```

000.0 to 590.0 seconds



```
AM 25%          ProgNo 9*
time  0:01:30    0:00:00
pulse 000.5s     001.0s
temp  off max 35°C
```

000.0 to 599.0 seconds



```
AM 25%          ProgNo 9*
time  0:01:30    0:00:00
pulse 000.5s     001.0s
temp  off max 35°C
```

000.0 to 600.0 seconds



proceed to next operating parameter



back to stand-by mode

### 3.2.3 Temperature monitoring [temp]

The temperature in the sonicating medium can be monitored using the temperature sensor. The following functions can be set:

- off no monitoring
- stop when reaching or exceeding the set temperature limit value, the ultrasound operation will be turned off. If the temperature falls short of the limit value once again, the ultrasound operation will not continue.
- alarm when reaching or exceeding the set temperature limit value, an acoustic and visual warning signal (red blinking LED) will be triggered. The ultrasound operation will not be turned off.

#### a) Setting the type of monitoring

```
AM 25%          ProgNo 9*
time  0:01:30    0:00:00
pulse 000.5s     001.0s
temp  off max 35°C
```



```
AM 25%          ProgNo 9*
time  0:01:30    0:00:00
pulse 000.5s     001.0s
temp  stop max 35°C
```



```
AM 25%          ProgNo 9*
time  0:01:30    0:00:00
pulse 000.5s     001.0s
temp  alarm max 35°C
```



## b) Setting the temperature limit value

The maximum setting value is 120 °C.

AM	25%	ProgNo	9*
time	0:01:30		0:00:00
pulse	000.5s		001.0s
temp		off max	35°C



or



back to stand-by mode

## 3.2.4 Special functions

Additional functions are available within a second menu level. These can be accessed by pressing and holding the “MENU” button for approximately 2 seconds. Switching between these functions is accomplished in the manner already described. The menu level can only be exited by pressing the “START/STOP” button. In doing so, settings and function statuses are accepted and executed.

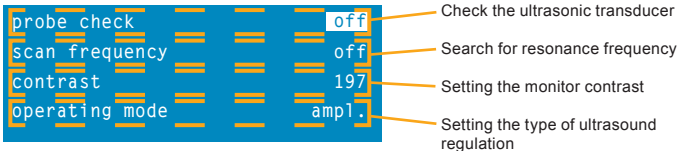

### Check the ultrasonic transducer [probe check]

This function is used for quick verification as to whether the ultrasonic transducer is recognised by and can be correctly activated by the HF generator. After a change in probe or in operating conditions, it could be the case that the HF generator, for example, cannot synchronise with the ultrasonic transducer and issues an error message, e.g. Error 011. The HF frequency is reset to the base value and the function is restored if no device fault or other cause is present.

The set value is “off”. In order to activate the function, set the parameter to “start” using the rotary knob, and then press the “START/STOP” button. See chapter 6.2.1 for additional information.

### Search for resonance frequency [scan frequency]

This function is an expansion of the above-mentioned “probe check” function. In addition, a frequency scan is conducted in order to determine the correct HF or ultrasound frequency for the ultrasonic transducer. Depending upon the probe used and the operating conditions, the frequency can fluctuate significantly, in some instances. When switched off, the HF generator saves the current frequency value and uses it as the start value when switched on again. If there are significant deviations in the current HF frequency, this can lead to malfunctions.



#### Note:

After a successful scan while in continuous operation (pulsation = off, time > 30 s), start with an amplitude setting of 50 % and check the operation. Next, set the desired value.

### **Setting the monitor contrast [contrast]**

With this function, the monitor contrast can be adapted to the local light conditions. The contrast values range between 1 and 255, and can be set by turning the rotary knob. Smaller values result in a darker image and larger values result in a lighter image. The default value is 190.

### **Type of ultrasound regulation [operating mode]**

Here you can define whether the ultrasonic homogenizer is to work with amplitude or power control.

ampl. → Amplitude control = constant amplitude

Thanks to the direct data logging in the ultrasonic transducer (AMPLICHRON® system), the amplitude is precisely and quickly measured and set. In the process, the power output may fluctuate based on the physical state of the medium.

power → power control = constant power output

The control variable is calculated based on the measured electrical HF power, and has a process-dependent time delay. Only the average of larger fluctuations is balanced. Depending on the physical state of the medium, the amplitude may fluctuate. This type of regulation cannot be recommended for reproducible results.

### 3.3 Loading / saving sonication programmes

The ultrasonic homogenizer possesses a working memory and 9 memory locations for sonication programmes.

In order to work with a sonication programme, it must first be loaded into the working memory. If changes in the operating parameters are made in the working memory, a \* (asterisk) will appear after the program number [ProgNo]. If these changes need to be available later as samples, the current operating parameters may be saved on one of the 9 memory locations.

The memory management is called up with the “PROG” button and the content of the selected memory is displayed.

AM	20%	ProgNo	9
time			non-stop
pulse	000.1s		000.5s
temp		off max	35°C

The sonication programmes can be individually selected using the rotary knob. Memory location 0 represents the working memory.

#### Loading the sonication programme

After selecting the desired sonication programme, the parameters are transferred to the working memory by pressing the “START/STOP” button, and they can be used or processed in that location.

#### Saving the sonication programme

In order to store the content of the working memory in the selected memory location, e.g. programme 2, press and hold the “PROG” button until a signal tone is heard. The saving process is now concluded and the new content is displayed. By pressing the “START/STOP” button you return to stand-by mode.

AM	25%	ProgNo	9*
time	0:01:30		0:00:00
pulse	000.5s		001.0s
o.k.		→	[start]

If you need to exit the memory management without making changes, you can either press the “MENU” button (termination of the mode) or set the programme number [ProgNo] to 0 and then press the “START/STOP” button (the working memory will overwrite itself).

### 3.4 Activating / deactivating the ultrasound

Ultrasound operation can be started and stopped by pressing the “START/STOP” button or the button on the ultrasonic transducer. Ultrasound operation ends once the target time has elapsed (if a time has been set), and a signal tone (long + short) is emitted. When the device is restarted, the displays for the elapsed sonication time and for the energy are set to zero.

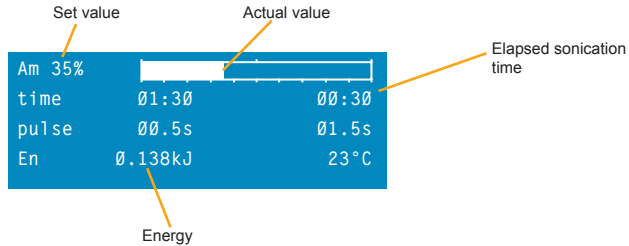

In contrast to stand-by mode, ultrasound operation displays the actually-achieved value in bar graph form, in addition to the pre-set amplitude or power.



**Note:**

Depending upon the physical conditions, i.e. the viscosity of the sonicated medium and the thus-resulting control processes, a difference between the specified and the actual value, as well as a fluctuating display, may occur.

The amplitude and the power can be changed at any time during ultrasound operation, using the rotary knob. All other operating parameters can only be edited while in stand-by mode (see chapter 3.2).



**Notes:**

- If the ultrasound operation is manually interrupted before it reaches the activated target time, the display values for the elapsed sonication time and for the energy will be saved and will continue running upon restart. The display values can be reset to zero by pressing the “MENU” button and then pressing the “START/STOP” button.
- With the “non-stop” setting, the elapsed sonication time and energy must also be manually reset, if needed. Once the maximum displayable time has been reached and exceeded, the time display will start again at 0:00:00.
- If the maximum displayable energy value of 99999.99 kJ is exceeded, the display starts again at 0.000 kJ.
- The displayed value for energy is calculated based on the HF energy applied and can be used as an equivalent for the acoustic ultrasound energy under consideration of the efficiency.

## 4 Use

### 4.1 Instructions for use



- Do not touch the sonication vessels with the oscillating probe - probes and vessels could be damaged.
- The recommended immersion depth for probes is of 10 - 20 mm, to prevent the aspiration and mixing-in of air. If mixed-in air is desired, the probe may be immersed just a few millimeters. In the case of greater immersion depths and/or the sonication of liquids with high viscosity, the probe is more heavily damped. As a result, it is possible that the pre-set amplitude (power) may not be reached, especially with higher default settings (>50 %). The reason is that the HF generator can no longer provide the required power, or the power limit value has been reached (protective function).
- The immersion depth may not exceed 20 mm in the case of micro and tapered tips.
- When producing emulsions, the probe should be immersed to the level of the interface between the liquids to be mixed.
- Do not use combustible solvents in open reaction vessels since the operating safety of the homogenizer could be compromised.



- In order to shut down the device, disconnect it from the mains (pull the plug).

### 4.2 General use

Before starting use, the important instructions under chapter 4.1 are to be heeded!

#### **Step 1 : Check the ultrasonic transducer**

- Verify that all connecting cables and couplings are correctly connected.
- The probe type must conform to the sonication volume, see table in chapter 4.3.
- The probe must be clean, faultless, and firmly mounted.
- The ultrasonic transducer must be securely affixed.

#### **Step 2 : Prepare the sonication**

- Prepare the sonication medium.
- Position the sonication vessel below the ultrasonic transducer in such a manner that the probe does not come in contact with the vessel.
- Set the immersion depth for the probe (approx. 1 - 2 cm).
- If needed, connect the temperature sensor and position it in the medium.



### **Step 3 : Turn on the homogenizer**

- Turn on the homogenizer with the power switch.
- All saved data and settings will be loaded. Check the settings and load a different programme if necessary, see chapter 3.3.

### **Step 4 : Activate the ultrasound**

- Select a small amplitude at the start to prevent any splashing onto the ultrasonic transducer. Observe the maximum-allowed amplitude, see chapter 4.3.
- Activate the ultrasound



Warning, risk of splashing!

This is especially the case with small sample quantities and when immersing oscillating probes.

### **Step 5 : Remove the sample**

After sonication, the probes are to be removed from the medium. Leaving them in the sonicating medium for a longer time can cause damage to the probe.

- Once the programme or time setting has elapsed, the delivery of ultrasound ends automatically.
- If continuous sonication has been set, the ultrasound delivery must be stopped manually.
- Remove the probe and the temperature sensor, if applicable, from the sonicating medium.

### **Step 6 : Clean the probe**

In order to prevent contamination with other sonicating media, probes are to be thoroughly cleaned after every sonication, see chapter 5.2.

- Turn off the homogenizer with the power switch.
- Clean the probe and check the wear on the sound emitting surface at regular intervals, see chapter 5.1.

## 4.3 Selection of suitable probe

Detailed information on the individual probes can be found in the separate product information. A graphic overview of accessory parts can be found in appendix A.

HD 3100						
Probe Ø	MS 72 2 mm	MS 73 3 mm	KE 76 6 mm	TT 13 13 mm	VS 70 T 13 mm	TT 13 FZ 13 mm
Connection to standard horn	SH 70 G, (FZ 5 G)					FZ 5 G
Sonicating vol.	1 ml - 25 ml	2 ml - 50 ml	5 ml - 100 ml	10 ml - 200 ml	10 ml - 200 ml	-
Amplitude	285 µm <sub>ss</sub>	245 µm <sub>ss</sub>	191 µm <sub>ss</sub>	93 µm <sub>ss</sub>	97 µm <sub>ss</sub>	93 µm <sub>ss</sub>
<b>Maximum-allowed amplitude setting</b>	<b>97 %</b>	<b>100 %</b>	<b>100 %</b>	<b>100 %</b>	<b>100 %</b>	<b>100 %</b>

HD 3200										
Probe Ø	MS 72 2 mm	MS 73 3 mm	KE 76 6 mm	TT 13 13 mm	VS 70 T 13 mm	TT 13 FZ 13 mm	TT 19 19 mm	VS 190 T 19 mm	TT 25 25 mm	VS 200 T 25 mm
Connection to standard horn	SH 213, SH 213 G, (FZ 7 G)					FZ 7 G	SH 219 G		SH 225 G	
Sonicating vol.	2 ml - 30 ml	5 ml - 90 ml	10 ml - 350 ml	20 ml - 900 ml	20 ml - 900 ml	-	25 ml - 900 ml	25 ml - 900 ml	30 ml - 1000 ml	30 ml - 1000 ml
Amplitude	286 µm <sub>ss</sub>	308 µm <sub>ss</sub>	255 µm <sub>ss</sub>	165 µm <sub>ss</sub>	170 µm <sub>ss</sub>	165 µm <sub>ss</sub>	81 µm <sub>ss</sub>	81 µm <sub>ss</sub>	53 µm <sub>ss</sub>	51 µm <sub>ss</sub>
<b>Maximum-allowed amplitude setting</b>	<b>52 %</b>	<b>65 %</b>	<b>72 %</b>	<b>100 %</b>	<b>100 %</b>	<b>100 %</b>	<b>100 %</b>	<b>100 %</b>	<b>100 %</b>	<b>100 %</b>

HD 3400		
Probe Ø	VS 190 T 19 mm	VS 200 T 25 mm
Connection to standard horn	SH 3419	SH 3425
Sonicating vol.	100 ml - 1500 ml	100 ml - 2500 ml
Amplitude	116 µm <sub>ss</sub>	82 µm <sub>ss</sub>
<b>Maximum-allowed amplitude setting</b>	<b>90 %</b>	<b>100 %</b>

### 4.3.1 Mounting and dismounting of the probes

Probes

- are screwed onto the standard or booster horns,
- transmit ultrasonic power into the medium to be sonicated,
- are made of high-strength titanium alloy.



Caution! Probes are sensitive to shock.

Before mounting the probes, the HF generator must be turned off and the ultrasonic transducer must be disconnected from the HF generator.

The mounting surfaces<sup>4</sup> are to be thoroughly cleaned so that the amplitude and/or power can be transmitted to the medium.

If the mounting surfaces are not cleaned, the probe, standard horn or booster horn could be ruined as a result.

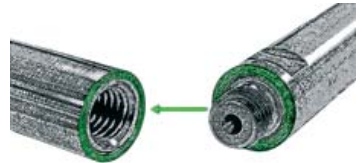

The tool required for mounting/dismounting is included in the scope of supply.

<sup>4</sup> The mounting surfaces are the contact surfaces between the individual accessory parts, e.g. between the standard or booster horn and the probe.

### 4.3.1.1 Mounting and dismounting of the titanium plates

- Titanium plate TT 13 /FZ, TT 19, TT 25
  - In HD 3100, the TT 13 is mounted onto standard horn SH 70 G, and in HD 3200 it is mounted onto booster horn SH 213 G.
  - In HD 3100, TT 13 FZ is mounted onto flow-through standard horn FZ 5 G, and in HD 3200, it is mounted onto flow-through booster horn FZ 7 G.
  - In HD 3200, TT 19 is mounted onto booster horn SH 219 G.
  - In HD 3200, TT 25 is mounted onto booster horn SH 225 G.
- First, carefully wipe the mounting surfaces of the standard and/or booster horns and of the respective titanium plate ⇒ ensure clean mounting surfaces.
- Screw on the titanium plate by hand.
- Apply spanners - SW 10 for TT 13 and TT 13 FZ, SW 15 for TT 19, SW 22 for TT 25 - to the spanner fitting on the titanium plate.
- Firmly hold the standard or booster horn using sickle spanner HS 40/42, and firmly mount the titanium plate to the standard or booster horn.
- Dismount in the reverse order.

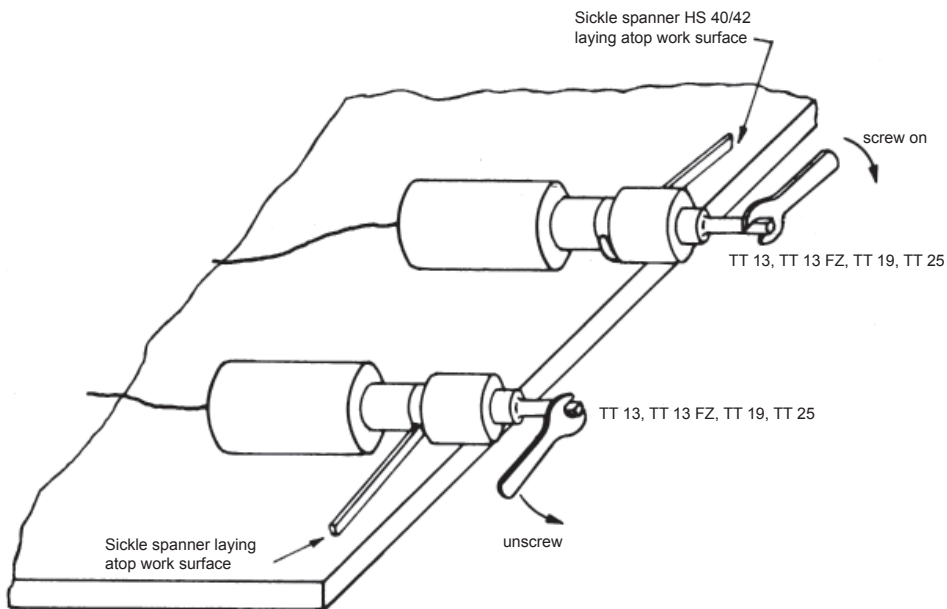

### 4.3.1.2 Mounting and dismounting of micro- and tapered tips and long probes

- Micro- and tapered tips (MS 72, MS 73, KE 76) and long probes (VS 70 /T, VS 200 /T)
  - On HD 3100, MS 72, MS 73 and KE 76 are mounted onto standard horn SH 70 G.
  - On HD 3200, MS 72, MS 73, KE 76, VS 70 /T are mounted onto booster horn SH 213 G.
  - On HD 3200, VS 190 T is mounted onto booster horn SH 219 G.
  - On HD 3200, VS 200 /T is mounted onto booster horn SH 225 G.
  - On HD 3400, VS 190 T is mounted onto booster horn SH 3419 G.
  - On HD 3400, VS 200 T is mounted onto booster horn SH 3425 G.
- First, carefully wipe the mounting surfaces of the standard and/or booster horns and of the probe ⇒ ensure clean mounting surfaces.
- Screw on the probe by hand.
- Lay the probe on an approx. 20 mm thick base so that it does not bend.
- Firmly hold the standard or booster horn in place using sickle spanner HS 40/42, and tighten the probe using the appropriate spanner, see illustration.
- Dismount is conducted in the reverse order.

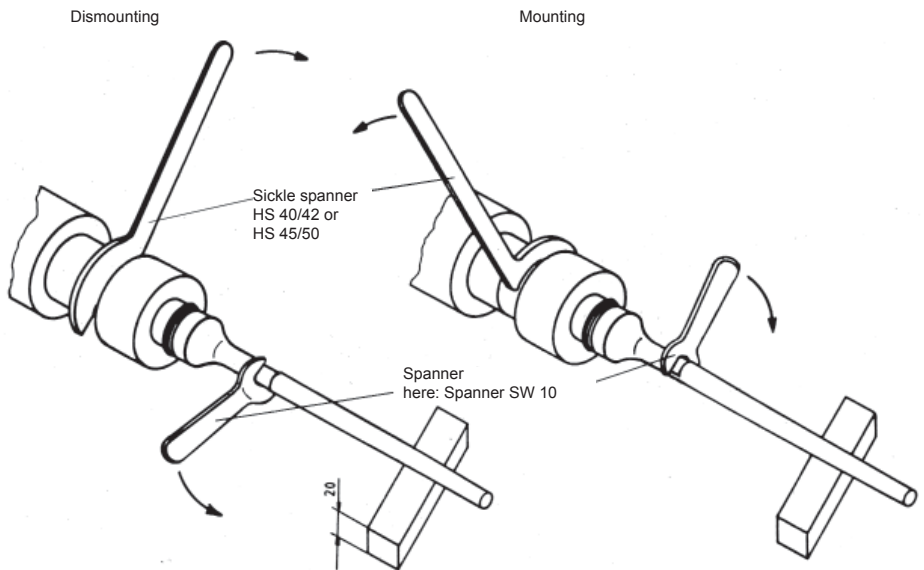

## 4.4 Mounting and dismounting of the standard and booster horns

Standard and/or booster horns

- are screwed onto the respective ultrasonic transducer,
- are made of high-strength titanium alloy,
- transmit the oscillations to the probe,
- enhance the amplitude thanks to their geometry.

At the time of delivery, standard horn SH 70 G, booster horn SH 213 G, and booster horn SH 3425 are firmly mounted onto the HD 3100, HD 3200, and HD 3400, respectively, on the ultrasonic transducer.

Before mounting the standard or booster horn, the HF generator must be turned off and the ultrasonic transducer must be disconnected from the HF generator.

- Release the firmly-mounted standard and/or booster horn SH 70 G, SH 213 G or SH 3425 from the ultrasonic transducer UW 3100, UW 3200 or UW 3400, respectively. To do so, lay the ultrasonic transducer on a firm (non-slip, if possible) base.

### Dismounting

- Place one sickle spanner on the ultrasonic transducer and the other sickle spanner on the standard or booster horn. To dismount, press the first sickle spanner against the firm base, press the other sickle spanner firmly in the opposite direction.
- One sickle spanner is part of the scope of delivery of one standard or booster horn.

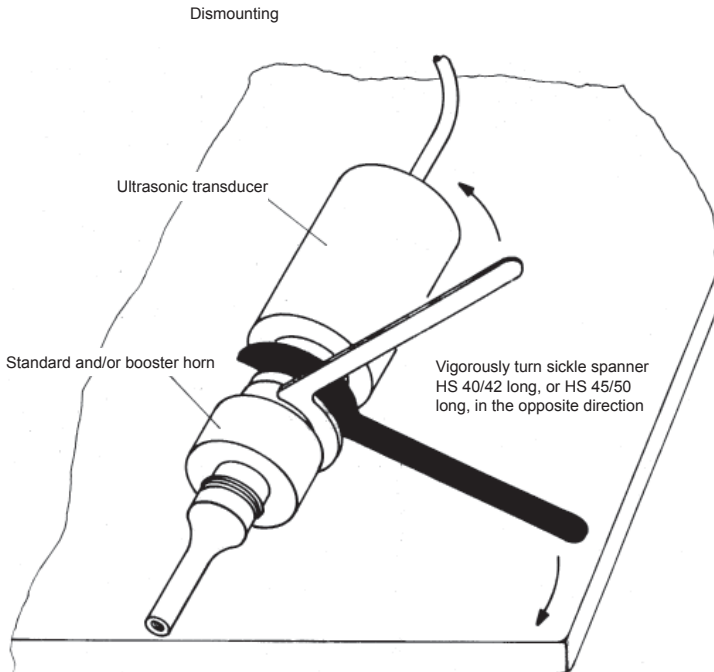

## Mounting

- Keep the surfaces/threads to be screwed clean; clean them with alcohol and a fibre-free cloth, if needed.
- Screw approx. 2/3 of the length of the threaded bolts of the new standard or booster horn to be mounted, into the mounting surface of the ultrasonic transducer.
- Place a plastic ruler or similar on the threaded portion of the bolt, and press lightly in the direction of the arrow ⇒ this will prevent the bolt from turning any further when the standard or booster horn is screwed on.

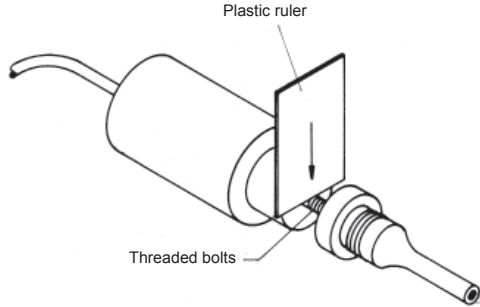

Screw the standard or booster horn onto the threaded bolt and first tighten by hand after removing the ruler.

- Then, mount the standard or booster horn firmly onto the ultrasonic transducer using both sickle spanners.

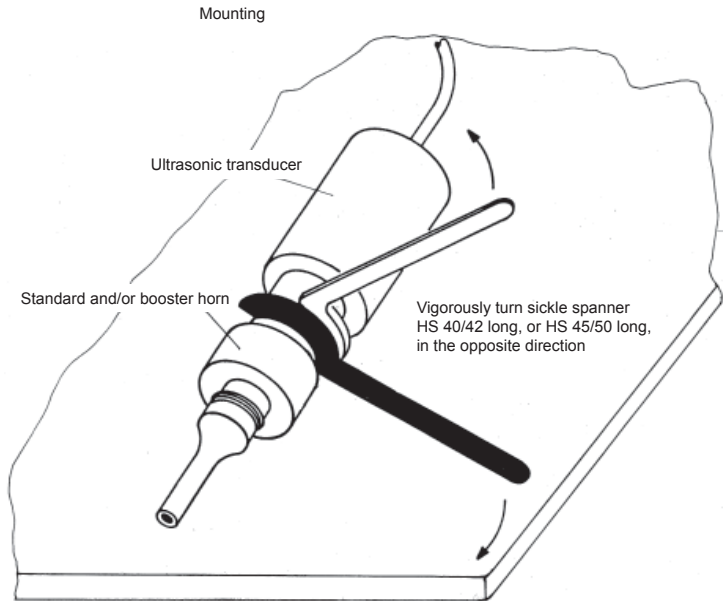

Detailed information on the individual standard and/or booster horns can be found in the separate product information.



The black housing of the ultrasonic transducer and the aluminium cylinder (ultrasonic oscillating system) may not be turned against each other. The ultrasonic oscillating system and its electrical connections would be damaged as a result.

## 5 Cleaning and maintenance of the homogenizer

To achieve an optimum lifespan for the homogenizer, cleaning and maintenance are to be conducted regularly.



### CAUTION!

Always disconnect the homogenizer from the mains before performing cleaning/maintenance.



Do not rinse or immerse the homogenizer in water and do not expose it to splash water.

**A guarantee will not apply to damages caused by the use of unsuitable disinfection agents or detergents.**

### 5.1 Cleaning and care

#### Probes

All probes are subject to process-related wear, which leads to erosion on the sound-emitting surface and thus to a reduction in power.

In the case of frequent use, it is recommended that a supply inventory of probes be kept.

Examples of wear, e.g. on titanium plate TT 13:



New titanium plate



Erosion still permissible, plate can be polished

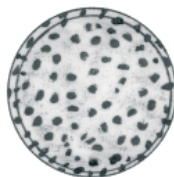

Start of pitting, milling or grinding necessary

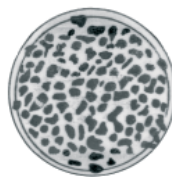

Limit value for erosion exceeded, replacement necessary

The sound-emitting surfaces can be carefully polished or milled a few times. If material residue due to erosion or post-processing exceeds a value of approx. 1 mm, or if there is no power display on the generator, the probe is non-resonant and can no longer be used.

Reconditioning of the sound-emitting surface:

Reconditioning can be performed using a grinding machine with a fine abrasive wheel of suitable grain size, or by hand using a diamond file. Suitable grinding materials are, for example:

- Fine abrasive wheel, polyurethane-bound – grain size 150
- Fine abrasive wheel, rubber-bound – grain size 120
- Grinding wheel PNK, corundum – grain size 180 ... 280
- Diamond file, D 181 or D 251

#### UW/HF generator

- Do not use any abrasive cleaners, only commercial care products without abrasive additives.
- Housing is to be wiped off only from the outside with a moist cloth; afterwards, allow to dry alone or wipe dry.



## 5.2 Treatment of contaminated parts in the ultrasonic transducer, vessels and accessories pertaining to the medical field



When working with ultrasonic homogenizers, the sonicating parts, vessels and other accessories (e.g. stands, mounting tools) could be contaminated with microorganisms or toxicologic agents and lead e.g. to cross-infections. Disinfection and/or cleaning is required.

In the event of incorrect or irregular disinfection and cleaning, contamination is possible, especially at the connecting points (e.g. between titanium plate and standard horn) and at the sound-emitting surfaces (see chapter 5.1, Wear).

Therefore, the sonicating parts (such as the standard or booster horn, micro- or tapered tips, and titanium plates), vessels and accessories are to be disinfected and cleaned, and dismantled for this purpose if necessary, after every use.

In the event of toxic contamination, the applicable regulations and provisions of the BGR 250/ TRBA 250 are especially to be observed.

The disinfection and cleaning should be performed regularly by the operator, if applicable in accordance with the hygiene plan and using a VAH-certified or effective surface disinfectant.



### Note:

Additional information and provisions locally applicable at the user's/operator's site are to be observed.

## 5.3 Warehousing / storing

During extended periods without use, the homogenizer should be stored in a cool, dry place. The ultrasonic transducer should be covered in order to protect the electronics from outside contamination.

# 6 Maintenance and repair

## 6.1 Maintenance

SONOPULS homogenizers are maintenance-free.

Aside from the process-dependent cavitation erosion on the sound-emitting surface of the probes, no other homogenizer parts are subject to wear. Worn out or faulty probes can be replaced following the instructions in chapters 4.3.1 to 4.4.

The devices are calibrated at the time of delivery. A control of the calibration is only required after repairs, and is only conducted by the manufacturer.

## 6.2 Functional checks

See also chapter 3.2.4 for description and operation

### 6.2.1 Testing the ultrasonic transducer (probe check) – Error 011

The test is preferably conducted while the probe is acoustically uncoupled, i.e. the probe should not be immersed in the sonicating medium.

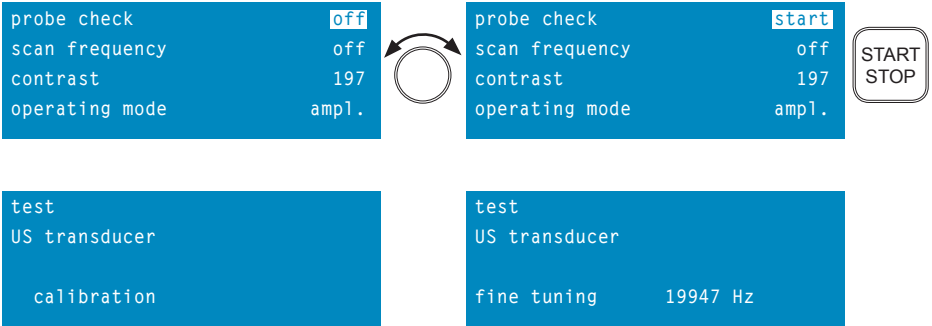

The HF or ultrasound frequency depends on the probe, and the actual value may vary from the example presented here. After successful completion, the monitor display switches back to stand-by mode. Otherwise, an error message appears again.

### 6.2.2 Conducting a frequency scan (scan frequency) – Error 002/011/012

The conditions for execution are similar to those for conducting checks with the “probe check” function, see chapter 3.2.4.



searching  
resonance frequency

calibration

searching  
resonance frequency

scanning 20496 Hz

searching  
resonance frequency

fine tuning 19945 Hz

The frequency scan is completed once fine-tuning has been successful, and the display switches back to stand-by mode.

Otherwise, an error message such as Error 012 appears again.



### **IMPORTANT**

Only allow repairs to be conducted by authorised skilled personnel !

Kindly inform us in writing of any malfunctions – use the enclosed questionnaire.



### **Important information**

- Before each repair, turn off the device and disconnect the plug from the mains!
- Defective parts may only be replaced with original parts.

The black housing of the ultrasonic transducer and the aluminium cylinder (ultrasonic oscillating system) may not be turned against each other. The ultrasonic oscillating system and its electrical connections would be damaged as a result.

## 6.3 Error analysis

Errors may arise

- on the plug connections
- on the ultrasonic transducer
- on the probes
- on the HF generator

The device is robustly constructed and designed for a high level of reliability. Nevertheless, the possibility of a malfunction due to a defective component can never be fully discounted. Mechanical defects of the HF connector sockets, the plug connectors, the ultrasonic transducer, etc. are also possible as a result of frequent use or even incorrect handling, e.g. by dropping them.

Critical faults are recognised by the device and signaled by a red LED and an intermittent signal tone (3 times), and displayed with an error number, see next page.

Monitor display	Error No.	Significance	Cause / Measure	Remedial action
<p>Error !!! 003  please  contact service</p>	003	No power output	Device fault → Repairs only through Customer Service	<ul style="list-style-type: none"> <li>- Send in homogenizer for repair since fault is severe</li> </ul>
<p>Error !!! 011  please  check the probe</p>	002	Frequency setting not possible	Ultrasonic transducer or probe faulty. Replace parts and check function (conduct a "probe check" or "scan frequency") If no success → Repairs only through Customer Service.	<ul style="list-style-type: none"> <li>- Check the connection to the probe and/or to the titanium plate. Is the cable properly plugged in and affixed? Is the probe or the titanium plate correctly screwed on? Check for erosion on the probe or titanium plate.</li> <li>- Once error rectified, conduct the "probe check" or "scan frequency" function (see chapter 6.2).</li> </ul>
	011	No response signal from the ultrasonic transducer		
	012	No resonance frequency found		
<p>Error !!! 014  max. temperature  exceeded</p>	014	Permissible internal operating temperature exceeded. Ultrasonic homogenizer turns off.	Allow the ultrasonic homogenizer to cool down.	<ul style="list-style-type: none"> <li>- Wait until the HF generator has sufficiently cooled. The operating temperature must be &lt; 50 °C.</li> </ul>

## General device errors

Error	Possible cause	Remedial action
Device cannot be switched on? (display without function)	No power Mains cable loose or faulty?  Device fuse tripped?  Main fuse faulty?	<ul style="list-style-type: none"> <li>- Check the plug connection for firm positioning.</li> <li>- Check the cable for continuity or, if needed, exchange the mains connector.</li> <li>- Exchange the fuses The fuses are located in the panel-mounted plug on the rear side of the generator, see chapter 1. (2 fuses: F2A)</li> <li>- Exchange the main fuse.</li> </ul>
Little or no ultrasonic power?	<p>Is the connection from the ultrasonic transducer to the standard or booster horn, or from the horn to the probe not secure? Standard horn, booster horn, or probe faulty?</p> <p>Check for erosion on the titanium plate / probe - see chapter 5.1. slight?  some pitting?  heavy?</p> <p>Has liquid seeped in between the standard or booster horn and the probe?</p> <p>Is the threaded pin attachment on the titanium plate defective?</p> <p>Are the threaded bolts on the standard and/or booster horns cracked?</p> <p>Wrong resonance frequency?</p>	<ul style="list-style-type: none"> <li>- Using the tool supplied, separate parts from one another, clean the surfaces, and firmly screw together once again, see chapter 4.3.1 ... 4.4.</li> <li>- Check the horn, probe and threaded pins for cracks, if necessary remove and replace. ⇒ Ensure that the surfaces are clean and smooth, see chapter 4.3.1.</li> <li>- Polish the titanium plate and/or probe.</li> <li>- Mill the titanium plate and/or probe until flat, or grind (max. 1 mm).</li> <li>- Replace the titanium plate and/or probe with new ones?</li> <li>- Dismount the probe, clean the mounting surfaces and threads, dry and check for evenness, remount the probe and tighten, see chapter 4.3.1.</li> <li>- Replace the titanium plate, see chapter 4.3.1.</li> <li>- Dismount the parts, check the threaded bolts, replace if necessary, remount the parts, see chapter 4.3.1.</li> <li>- Conduct frequency scan, see chapter 6.2 (search frequency).</li> </ul>
Significant heating in the vicinity of the mounting surfaces between the ultrasonic transducer – standard and/or booster horn, or standard and/or booster horn – probe?	<p>Sonicated parts (standard and/or booster horn and probe) not mounted firmly enough?</p> <p>Are mounting surfaces of the sonicating parts soiled?</p>	<ul style="list-style-type: none"> <li>- Dismount the respective parts, clean the surfaces and firmly retighten, see chapter 4.4.</li> </ul>

If it is not possible to rectify the fault using these short instructions, please contact your local specialist dealer or write us to the address below.

## 6.4 Repairs and service

If you identify errors or defects that cannot be rectified, use of the homogenizer must be halted. In such a case, please contact the supplier or the manufacturer:

BANDELIN electronic GmbH & Co. KG  
Heinrichstraße 3-4  
12207 Berlin

Repairs/Maintenance department:  
Tel.: +49-(0)-30 – 768 80 – 13  
Fax: +49-(0)-30 – 76 88 02 00 13

E-mail:  
info@bandelin.com

In the event of returns, the General Terms and Conditions for Delivery and Payment of BANDELIN electronic GmbH & Co. KG apply.

In addition, the homogenizer is to be cleaned and decontaminated (if necessary), see the following chapter.

### 6.4.1 Decontamination certificate

If the homogenizer is sent back to the manufacturer for repairs (with accessories, if applicable), the form "Certificate of Decontamination" is to be filled out and affixed to the packaging on the outside, in a visible spot.

If this form has not been filled out, we reserve the right to refuse receipt of the package in order to protect our employees.

The form can be downloaded from the Internet as a PDF file:

[www.bandelin.com](http://www.bandelin.com) - Download ...

A sample copy can be found in appendix D.

### 6.4.2 Software version display

In some cases it may be necessary to inform authorised skilled personnel or the manufacturer of the software version for the homogenizer.

After the HF generator is turned on (power switch) and initialisation is complete, press and hold the "PROG" button and press the "START/STOP" button simultaneously. An ultrasonic transducer must not be connected.

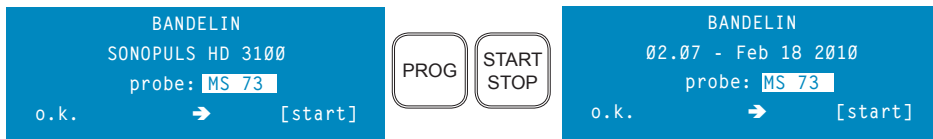

The software version provided here is an example, the actual specifications may differ.

## 7 Accessories

The proper accessories facilitate use of the ultrasound and also protect the device and materials used at the same time.

BANDELIN offers a broad range of accessories, see appendix.

Additional information may be obtained from our supplier, our sales representatives, or from our website.

No-obligation telephone consultation:  
+49-(0)-30 – 768 80 – 0

Website:  
[www.bandelin.com](http://www.bandelin.com)

### 7.1 Required accessories

#### Stand

Stands are used for correct, variable positioning of the ultrasonic transducer.

Only ultrasonic transducers, and not oscillating elements such as standard or booster horns with probes, may be affixed to the special clamp.

#### Sound proof box

The sonication of liquids generates noise. The sound proof box (z. B. LS 8) mutes the sound emission up to approximately 20 dB-AU.

The ultrasonic transducer is inserted into the supporting ring from above, and locked in place if needed.



In order to mount / dismount standard horns, booster horns, or probes, only use the spanner provided in appendix B.

### 7.2 Optional accessories

The following standard or booster horns can be connected to the ultrasonic transducer:

Homogenizer	HD 3100	HD 3200	HD 3400
Ultrasonic transducer	UW 3100	UW 3200	UW 3400
Scope-of-delivery standard and/or booster horn	Standard horn SH 70 G	Booster horn SH 213 G	Booster horn SH 3425
Special accessories (must be ordered separately)	Diamond standard horn DH 13 G Flow-through standard horn FZ 5 G	Booster horns SH 219 G SH 225 G Diamond standard horn DH 13 G Flow-through booster horn FZ 7 G	Booster horn SH 3419



### Remote control programme

The following accessories are required to operate the remote control (see chapter 1.4.3) via the digital infrared interface:

- Infrared adapter IR 1
- WINPULS PC-remote control programme

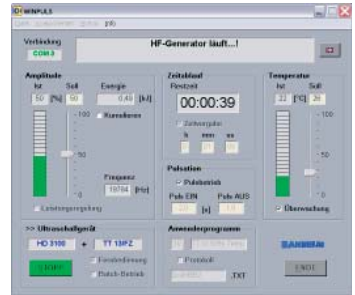

## 7.3 Preparations - not applicable -

## 8 Consumable materials - not applicable -

## 9 Taking the unit out of service

If the homogenizer no longer works, it must be disposed of appropriately. Some electrical components are considered to be toxic waste.



## 10 Key words

### A

Accessories	3, 6, 12, 14, 33, 39, 40, 41
Ambient conditions	9, 10
Amplitude	7, 8, 16, 17, 21, 23, 24, 25, 27, 30
Amplitude regulation	21
Amplitude setting	20, 26
Amplitude setting range	8

### B

Bar graph	23
Booster horn	6, 7, 12, 14, 27, 28, 29, 30, 31, 33, 40
Button	6, 8, 10, 16, 18, 23

### C

Calibration	34
Cleaning	32, 33
Contamination	25, 33
Continuous operation	8, 16, 17, 20

### D

Damage	9, 12, 13, 14, 25, 32
Decontamination	39
Degree of protection	8, 10
Disinfection	33
Dismounting	12, 13, 27, 28, 29, 30, 40

## E

Energy	7, 8, 16, 17, 23
Error message	15, 20, 34, 35
Examples of use	7

## F

Faults	13, 34, 35, 36
Foot switch	8, 10
Frequency (RF-)	7, 8, 9, 10, 20, 34
Functional check	9, 34

## G

Grounded socket	12, 14, 15
Guidelines	7

## H

Hearing protection	3, 12
HF frequency	9, 20
HF generator	6, 7, 8, 9, 11, 12, 14, 15, 16, 20, 24, 27, 30, 32, 36, 39
HF power	9
HF socket	6, 14
Homogenizer	6, 7, 8, 9, 12, 13, 16, 21, 22, 24, 25, 32, 33, 34, 37, 39, 40, 41
Housing	12, 13, 14, 31, 32, 35
Hygiene	12
Hygiene plan	33

## I

Interface	6, 8, 10, 11, 15, 41
IR adapter	8, 11, 41
IR interface	6, 8, 10, 11, 15, 41

## L

Laboratory field	13
Liquid	7, 12, 13, 24, 40

## M

Mains voltage	12, 14, 38
Maintenance	32
Maintenance	34
Maintenance service	39
Manufacturer	3, 7, 11, 13, 34, 39
Medical field	13, 33
Medical product	7, 9
Memory location	22
Menu	15, 16, 20
Micro tip	7, 12, 24, 29, 33
Microorganisms	7, 33
Mounting	8, 12, 13, 14, 27, 28, 29, 30, 31, 40
Mounting surface	27, 28, 29, 31, 38

## O

Operating element	8, 10, 12, 15
Operating mode	8, 11
Operating parameters	15, 16, 17, 19, 22, 23
Operating temperature	37
Operation	8, 9, 11, 12, 13, 16, 32, 41

## P

Piezo elements	14
Power setting range	9
Preparation of samples	7
Preset value	16, 17, 20, 21
Probe exchange	8, 20
Probes	7, 8, 9, 12, 13, 14, 15, 16, 24, 25, 26, 27, 29, 32, 34, 36, 38, 40
Product features	6
Product information	3, 26, 31
Protection class	9
Pulsation time	8, 16
Purpose	7, 9

## R

Reconditioning (probe)	32
Remote control	10
Remote control programme	11, 41
Remote control sleeve	6, 10
Remote operation	8, 10, 15, 41
Repair service	39
Repairs	13, 34, 35, 39
Resonance frequency	8, 20, 37, 38
Rotary knob	8, 15, 16, 20, 21, 22, 23
Rotational direction	28, 29

## S

Sample quantities	12, 25
Save options	15
Scope of delivery	3, 14, 27, 30
Serial number	6, 7, 9
Service	39
Sickle spanner	28, 29, 30, 31
Signal	10
Signal input	11, 12
Signal line	12
Signal output	12
Skilled personnel	13, 35, 39
Solvents	12, 24
Sonication	12, 17, 24, 25, 40
Sonication medium	7, 19, 24, 25, 34
Sonication programmes	22
Sonication time	16, 17, 23
Sonication vessel	12, 24
Sonication volume	24, 26
Sound proof box	12, 14, 40
Spanner	28, 29
Splashing risk	12, 25
Standard horn	7, 12, 14, 26, 27, 28, 29, 30, 31, 33, 40
Start-up	9, 12, 15
Suitable for continuous operation	10
Surface (sound-emitting)	25, 32, 33, 34

## T

Tapered tip	7, 12, 24, 29, 33
Technical data	8, 10
Temperature sensor	6, 8, 12, 16, 19, 24, 25
Threaded bolts	31, 38
Titanium plate	7, 12, 28, 32, 33, 37, 38
Tool	13, 27, 38
Type plate	6, 9, 14

## U

Ultrasonic transducer	6, 7, 8, 10, 12, 13, 14, 15, 18, 20, 21, 23, 24, 25, 27, 30, 31, 33, 34, 35, 36, 38, 39, 40
Ultrasound amplitude	7
Ultrasound operation	8, 10, 11, 17, 18, 19, 23
Ultrasound output	15, 25
Use	3, 13, 36

## V

Viscosity	9, 23, 24
Voltage source	11, 12

## W

WINPULS	11, 41
---------	--------

# A Options and accessories

## BANDELIN HD 3100

Optionen und Zubehör  
Options and accessories  
Options et accessoires

## SONOPULS Information

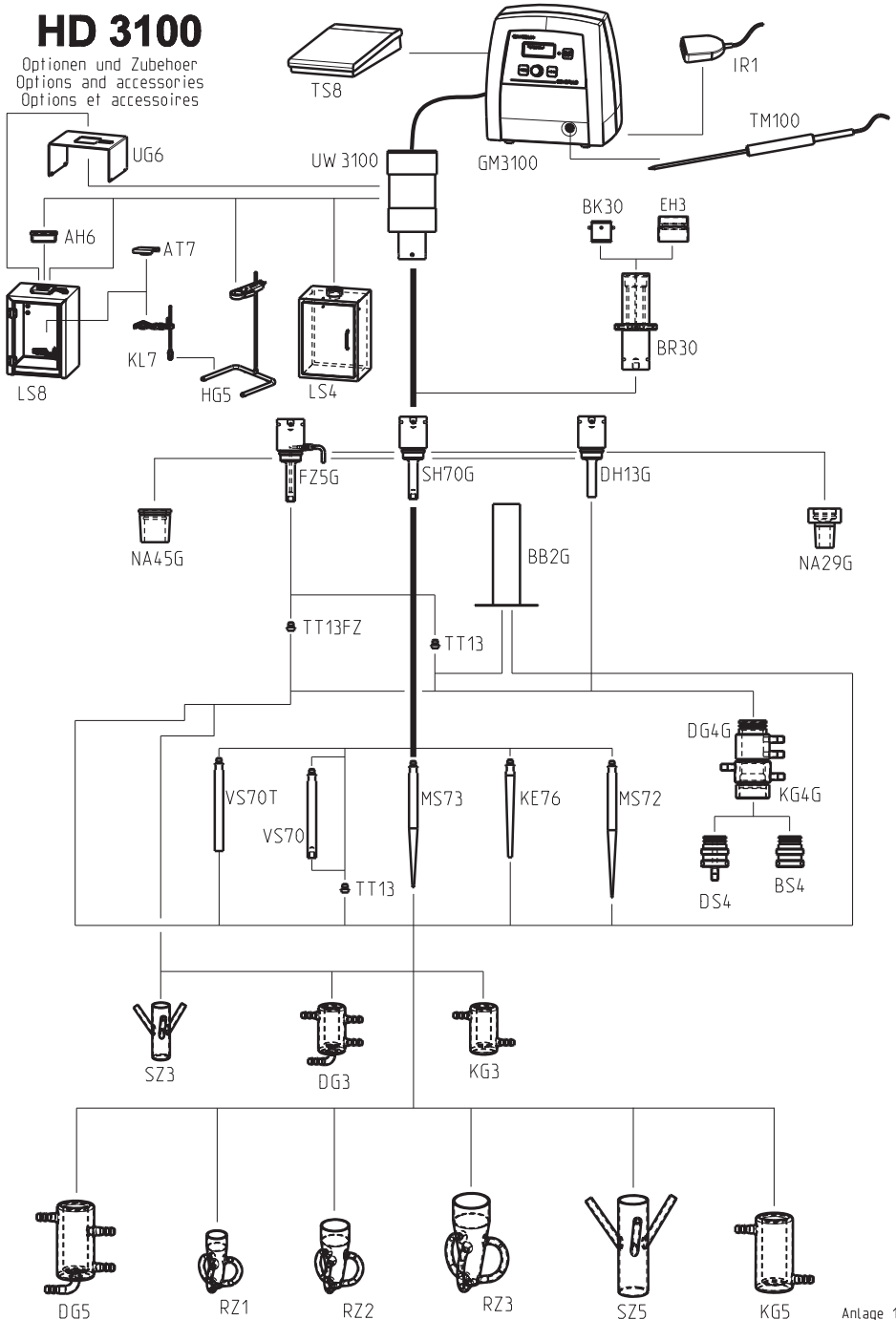

Antage 1  
Appendix 1  
Annexe 1

# BANDELIN

## HD 3200

Optionen und Zubehör  
Options and accessories  
Options et accessoires

# SONOPULS Information

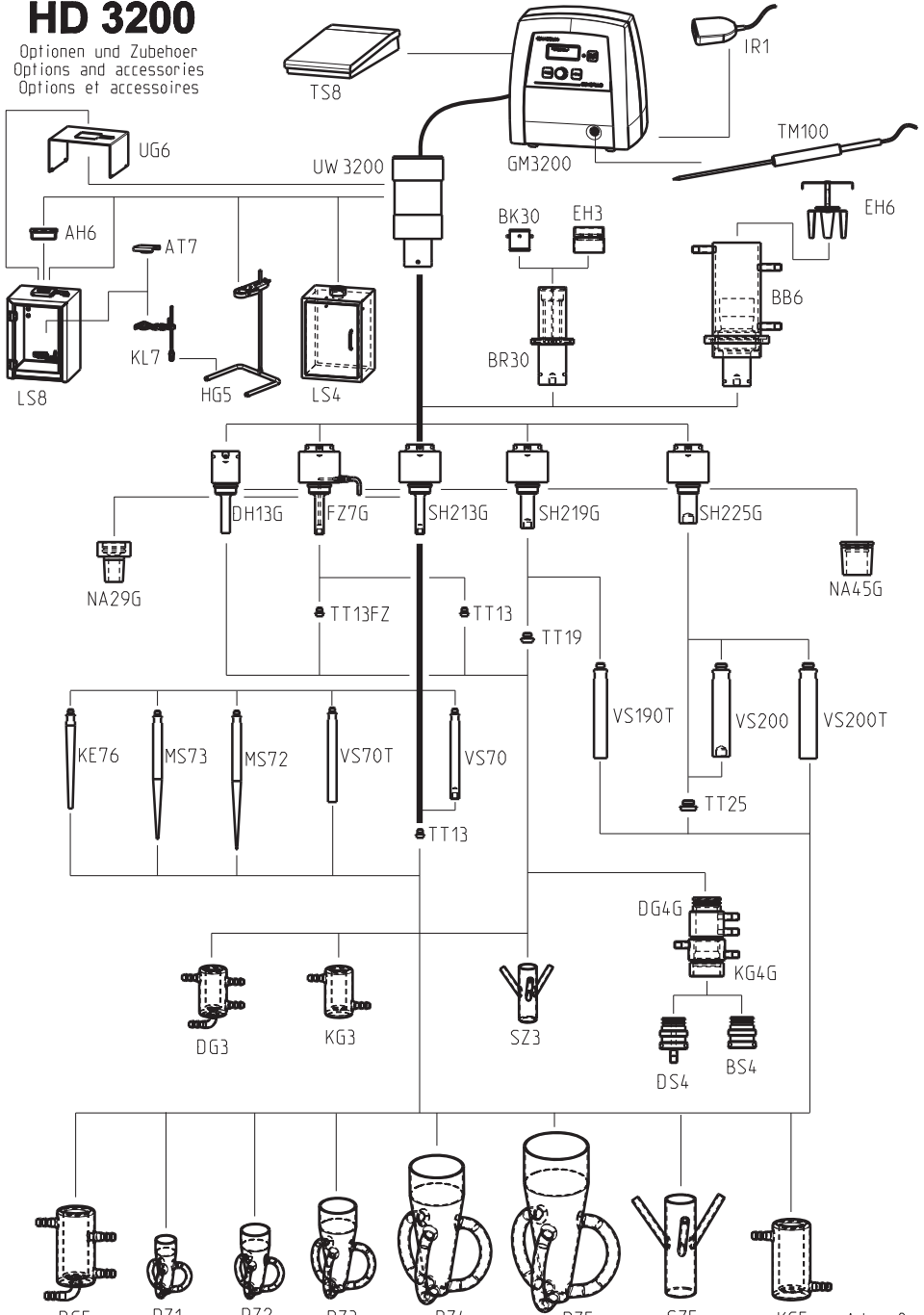

## HD 3400



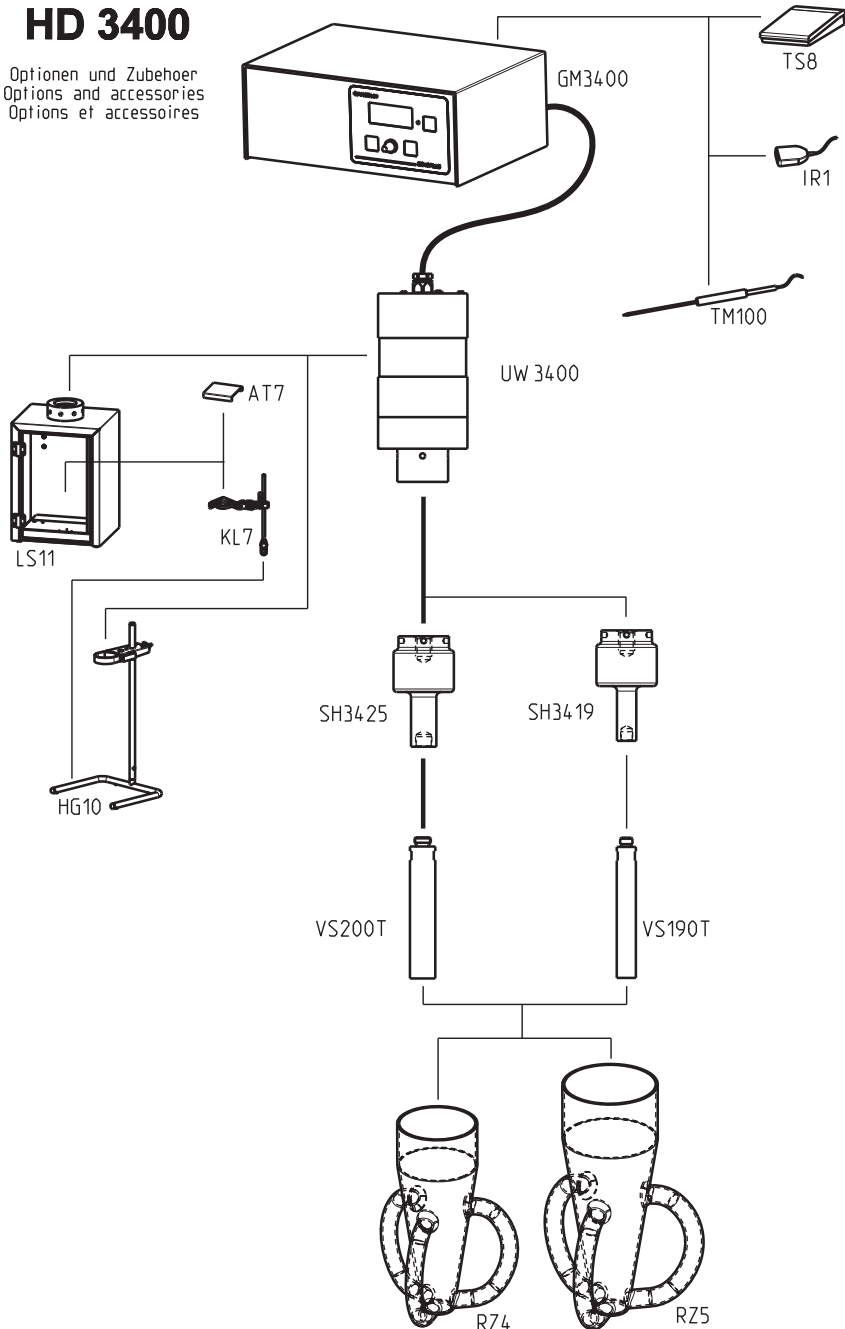

Optionen und Zubehör  
Options and accessories  
Options et accessoires

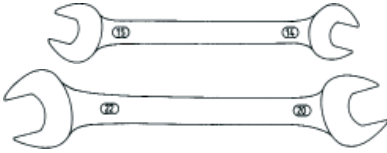

## B Spanner for mounting/dismounting

Probes, standard horns and booster horns are highly-sensitive parts that must be mounted and dismantled with the greatest amount of care.

For this reason, only use the following spanners for mounting/dismounting of probes from standard or booster horns, as well as of standard or booster horns from the ultrasonic transducer:

Spanner type	Use
<p>Spanner SW 10</p>  <p>Part of scope of supply.</p>	<p>In order to mount/dismount probes MS 72, MS 73, KE 76, TT 13 and TT 13 FZ ⇒ chapters 4.4 and 4.5 as well as probe extension VS 70</p>
<p>Spanner</p>  <p>Not supplied by <b>BANDELIN</b>.</p>	<p>To mount/dismount titanium plates TT 19 and TT 25            SW 15 for TT 19            SW 17 for VS 190 T            SW 22 for TT 25 ⇒ chapter 4.4 as well as probe extension VS 200</p>
<p>Sickle spanner HS 40/42</p>  <p>Part of the scope of supply of the homogenizer.</p>	<p>To mount/dismount all probes (used to hold the standard or booster horn firmly in place) ⇒ chapter 4</p>
<p>Sickle spanner HS 40/42, long</p>  <p>2 units are part of the scope of delivery of an additionally-ordered standard or booster horn.</p>	<p>For mounting/dismounting of standard and/or booster horns from the ultrasonic transducer ⇒ chapter 4.7</p>
<p>Sickle spanner HS 45/50, long</p>  <p>1 unit is part of the scope of delivery of the HD 3400.</p>	<p>To mount/dismount all probes (used to hold the standard or booster horn firmly in place) ⇒ chapter 4</p>

## C Electromagnetic ambient conditions (EMC)

Electromagnetic emissions		
The device is suitable for use in the electromagnetic environment specified in the following. The user is to ensure that the device is being used in such an environment.		
Transient emission measurements	Compliance	Electromagnetic environment - Guidelines
HF emissions according to CISPR 11	Group 1	The device uses HF energy only for its internal function. The HF emission is therefore very low and the probability that neighbouring electronic devices are damaged is unlikely.  The device is suitable for use in areas other than living spaces and those areas that are directly connected to a public power supply system that also powers buildings used for residential purposes.
HF emissions according to CISPR 11	Class B	
Emission of harmonic oscillations pursuant to IEC 61000-3-2	Class A	
Voltage fluctuations/ flicker emissions according to IEC 61000-3-3	Complies	

Resistance to electromagnetic interference			
The device is suitable for use in the electromagnetic environment specified in the following. The user is to ensure that the device is being used in such an environment.			
Electromagnetic interference checks	IEC 60601-test level	Conformity level	Electromagnetic environment - Guidelines
Discharge of static electricity (ESD) according to IEC 61000-4-2	± 6kV contact discharge ± 8kV air discharge	± 6kV contact discharge ± 8kV air discharge	Floors should be made of wood or cement or be covered with ceramic tiles. If the floor is covered with synthetic material, the relative humidity must be at least 30 %.
Fast transient electrical interference / bursts according to IEC 61000-4-4	± 2kV for mains supply ± 1 kV for input and output lines	± 2kV for mains supply ± 1 kV for input and output lines	The quality of the supply voltage should be similar to that in a typical business or hospital setting.
Surge voltage (surges) according to IEC 61000-4-5	± 1kV normal mode voltage ± 2kV common mode voltage	± 1kV normal mode voltage ± 2kV common mode voltage	The quality of the supply voltage should be similar to that in a typical business or hospital setting.
Voltage dips, brief interruptions and fluctuations in the supply voltage according to IEC 61000-4-11	<5% $U_T$ (>95% drop in $U_T$ for 1/2 period) 40% $U_T$ (60% drop in $U_T$ for 5 periods) 70% $U_T$ (30% drop in $U_T$ for 25 periods) <5% $U_T$ (>95% drop in $U_T$ for 5s)	<5% $U_T$ (>95% drop in $U_T$ for 1/2 period) 40% $U_T$ (60% drop in $U_T$ for 5 periods) 70% $U_T$ (30% drop in $U_T$ for 25 periods) <5% $U_T$ (>95% drop in $U_T$ for 5s)	The quality of the supply voltage should be similar to that in a typical business or hospital setting.  The continuation of operation is guaranteed for the device, even after interruptions in the energy supply.
Magnetic field at the supply frequency (50/60Hz) according to IEC 61000-4-8	3A/m	3A/m	Magnetic fields at the mains frequency should be similar to the typical values found in a business or hospital setting.
Note: $U_T$ is the mains alternating voltage before applying the test levels.			



### Resistance to electromagnetic interference

The device is suitable for use in the electromagnetic environment specified in the following. The user is to ensure that the device is being used in such an environment.

Electromagnetic interference checks	IEC 60601-test level	Conformity level	Electromagnetic environment - Guidelines
			Portable and mobile remote devices should not be used at a distance to the device, including the cables, that is smaller than the recommended safety distance that has been calculated pursuant to the equation applicable to the transmission frequency. <b>Recommended safety distance:</b>
Conducted HF interference according to IEC61000-4-6	$3 V_{\text{eff}}$ 150 KHz to 80 MHz	$V_1 = 3 V_{\text{eff}}$	$d = 1.2\sqrt{P}$
Radiated HF interference according to IEC 61000-4-3	3 V/m 80 MHz to 2.5 GHz	$E_1 = 3 \text{ V/m}$	$d = 1.2\sqrt{P}$ for 80 MHz to 800 MHz $d = 2.3\sqrt{P}$ for 800 MHz to 2.5 GHz
			With P as the nominal output of the transmitter in watts (W) according to information from the transmitter manufacturer, and d as the recommended safety distance in metres (m). The field strength of stationary transmitting devices must be lower than the compliance level at all frequencies, as measured on site: Interference can be generated close to devices that carry the following warning sign:  

### Recommended safety distances for portable and mobile HF communication devices

The device is suitable for operation in an electromagnetic environment in which beamed HF interference is controlled. The user of the device can help to prevent electromagnetic interference by keeping a minimum distance between portable/mobile HF communication devices (transmitters) and the device, depending upon the output power of the communication device:

Nominal output of the transmitter in W	Safety distance pursuant to transmission frequency in m		
	150 kHz to 80 MHz $d = 1.2\sqrt{P}$	80 MHz to 800 MHz $d = 1.2\sqrt{P}$	800 MHz to 2.5 GHz $d = 2.3\sqrt{P}$
0.01	0.12	0.12	0.23
0.1	0.37	0.37	0.74
1	1.17	1.17	2.33
10	3.70	3.70	7.37
100	11.70	11.70	23.33

For transmitters rated at a power not listed above, the recommended distance can be estimated in metres (m) using the equation in the corresponding column, where P is the power rating of the transmitter in watts (W) according to information from the transmitter manufacturer.

- Note 1:** The higher value applies at 80 MHz and at 800 MHz.
- Note 2:** In order to estimate the safety distance for transmitters in the frequency range of 80 MHz to 2.5 GHz, an additional factor of 10/3 was used in order to reduce the probability that a mobile/portable communication device causes interference.
- Note 3:** These guidelines may not be applicable in every case. The spread of electromagnetic waves is influenced by absorption and reflection from buildings, objects, and humans.

## D Decontamination - Master copy

### Certificate of Decontamination

**!!! CAUTION !!!**

***This form must be visibly affixed  
to the outside of the package!***

This "Certificate of Decontamination" is intended to secure the occupational health and safety of our employees pursuant to the German Protection against Infection Act and trade association accident prevention regulations.

Please understand that we can only initiate work operations when this Certificate is submitted.

Before sending the unit back to us for inspection/repair, the unit and accessories must be cleaned pursuant to current laws and regulations and, if necessary, must also be disinfected with a surface disinfection agent listed by the VAH.

Device type: \_\_\_\_\_

Serial number: \_\_\_\_\_

Accessories: \_\_\_\_\_

Device / accessories ...	
are not contaminated:	<input type="checkbox"/>
were cleaned before shipping:	<input type="checkbox"/>
are free from toxic matter:	<input type="checkbox"/>
have been decontaminated and/or disinfected and no longer pose a health risk:	<input type="checkbox"/>

With what type of toxic materials have the device / accessories come into contact?

Corrosive

Biologically hazardous (e.g. microorganisms)

Toxic

Radioactive

None

# Certificate of Decontamination

**!!! CAUTION !!!**

***This form must be visibly affixed  
to the outside of the package!***

## Legally binding statement

I/We hereby declare that the device and accessories found in this package have been cleaned and/or disinfected pursuant to current laws and regulations and that the information provided in this declaration are correct and complete:

Company /  
Institute: \_\_\_\_\_

Street and  
number: \_\_\_\_\_

Postal code, city: \_\_\_\_\_

Department: \_\_\_\_\_

Name: \_\_\_\_\_

Telephone,  
extension: \_\_\_\_\_

Fax: \_\_\_\_\_

## **Reason for return:**

Thank you, in this  
way you help us to  
reduce costs.

\_\_\_\_\_  
Date

\_\_\_\_\_  
Signature

\_\_\_\_\_  
Company stamp

**Note:**

The user instructions in this and other languages, as well as further information, can be found on the enclosed CD.